

SIDE MOUNT SPIGOT
FOR USE WITH STANDARD RANGE SHS POLES

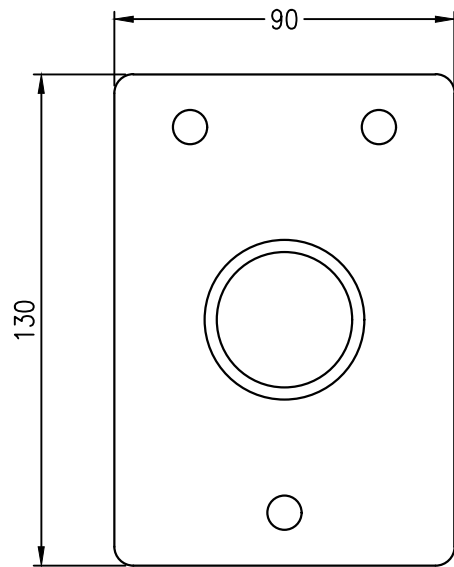

ELEVATION
SCALE 1:2

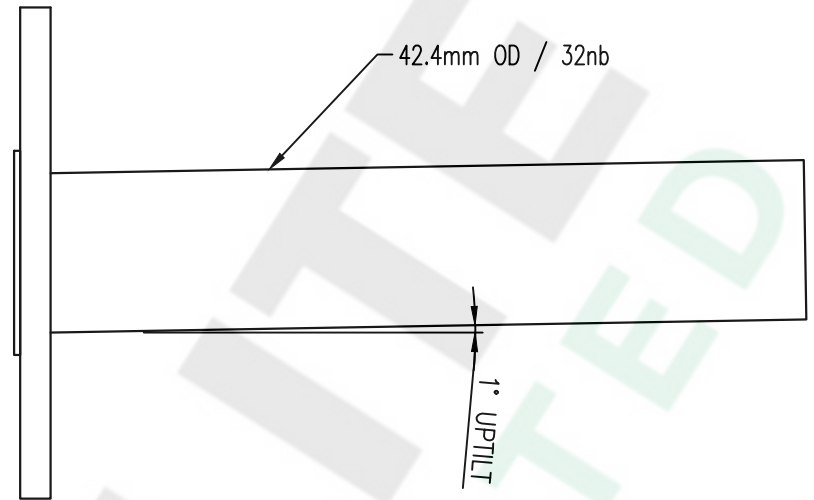

SIDE VIEW
SCALE 1:2

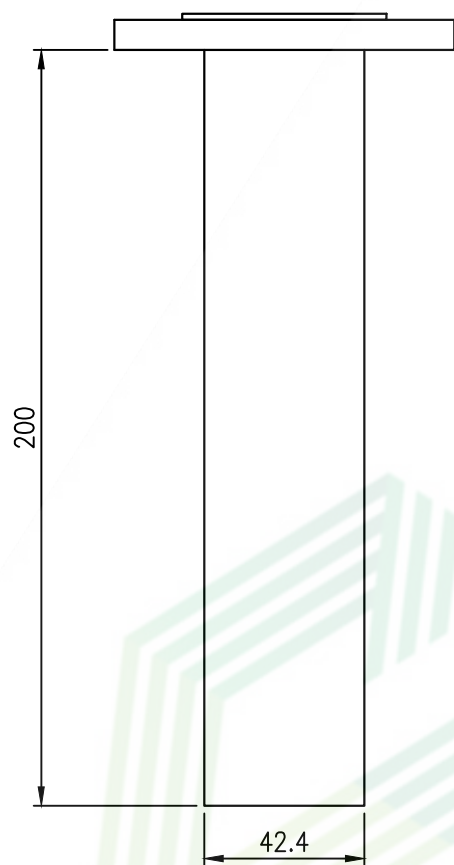

PLAN
SCALE 1:2

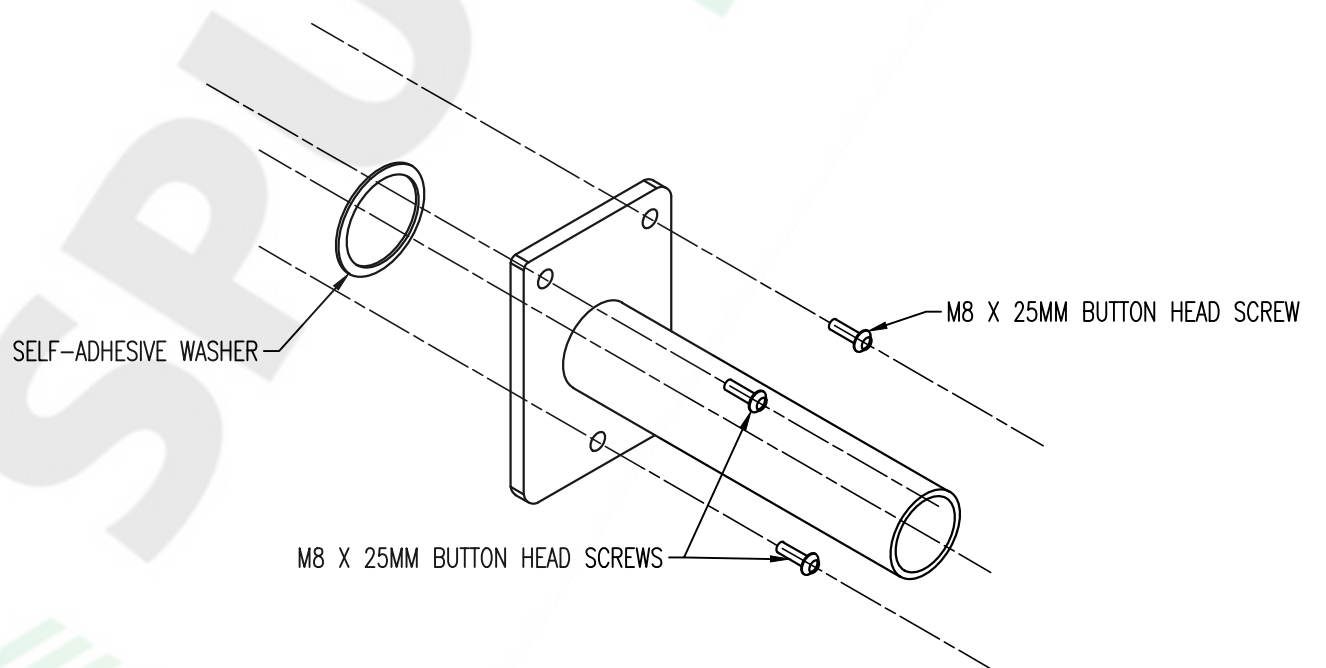

ISOMETRIC VIEW
SCALE 1:4

ESTIMATED WEIGHT = 2KG

Rev	Amendment Description	By	Chk	Date	DESIGN PARAMETERS:
1	SECOND PRODUCTION ISSUE	SG	MV	21.01.20	Design Working Life: 25 Importance Level: 1 Wind Region: A Terrain Category: 2 Site Elevation: <350m
					PRODUCT NUMBER
					SRSHSO/42200G
					DRG.SIZE
					A3
					SCALE
					AS SHOWN
					SHEET
					C1
					REVISION
					1



PRODUCT: STANDARD RANGE
TITLE: SHS SIDE MOUNT SPIGOT 42 O.D. x 200MM