

Structural Notes

- Minimum allowable soil bearing pressure shall be 100 kPa.
- Client to provide orientation and location.
- Contractor to check location of all services before commencing work.
- Provide conduit for cable entry as required.
- Only approved light fittings may be used, no additional attachments can be placed on pole without Spunlite's approval. (maximum light size=0.2m² with a cd=1.0, maximum light weight=15kg)
- Back fill hole with cement stabilised AP40 fill well compacted in 200mm layers or concrete.
- All dimensions shown are nominal.

NOTE: Foundation design information is supplied as a guide only. Other solutions may be more appropriate for specific situations. Due to variations in site conditions and installation procedures, Spunlite does not accept legal liability for the use of this information.

If requested Spunlite will design specific foundations for each project. Alternatively Spunlite recommends the engagement of a registered consulting engineer where upon Spunlite will supply all loadings.

A site evaluation by a qualified Structural/Geotechnical Engineer is advisable.

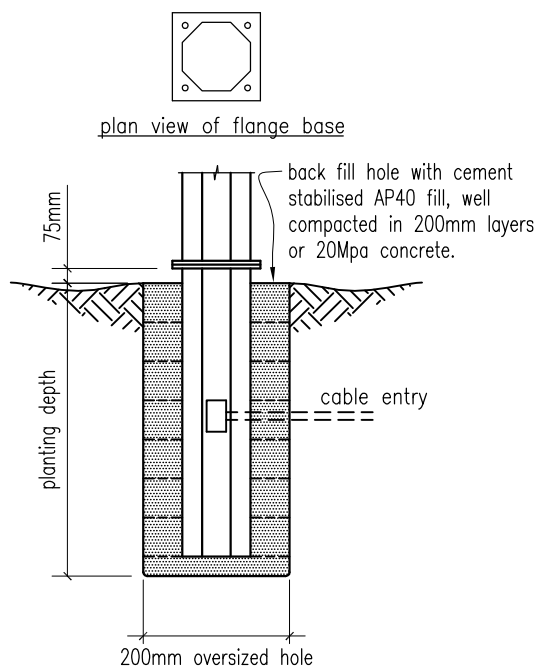

Typical Flange Based Stub Foundation



611 Halswell Junction Rd, Hornby, Christchurch, NZ
ph(03)349-7853 fax(03)349-6529 freeph(0800)845-845
i.net www.spunlite.co.nz

Project: -

Address: -

Title: Spunlite 14.0m Curved octagonal streetlighting pole, 4m
outreach (10°), flange based stub

Spun Lite Poles Ltd claim authorship of this work & retain intellectual & artistic copyright

scale: 1:75

file: 14.0c, fbs, 4, 10

date: 5/7/2001

drawn: ADL

sheet:

C1

revision: -